

**IMPORTANT**

## WIRING CONNECTION & INSTALLATION BEST PRACTICES

SHAPES AND COLOR IS A CONNECTION

KEEP MODULES AWAY FROM HEAT SOURCES

BEST GOOD WORST  
MOUNT WITH LOGO FACING UP AND/OR OUT TO A SIDE

SOLDER WIRE TIPS BEFORE SECURING TO TERMINALS

TERMINALS SHOULD BE SNUG AND NOT OVER-TIGHTENED

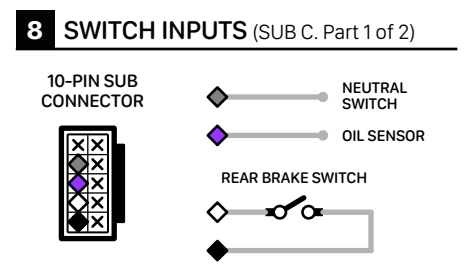
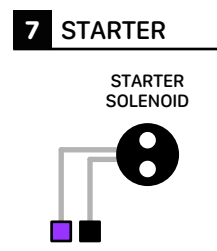
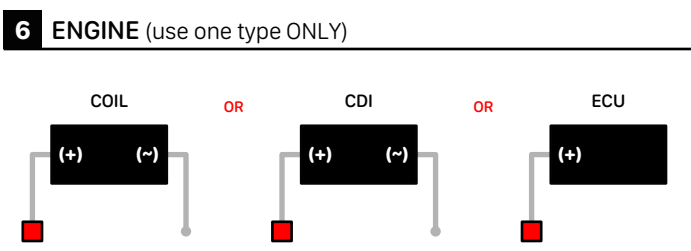
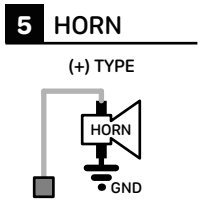
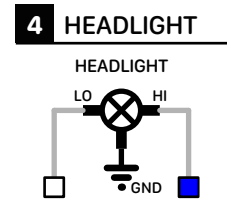
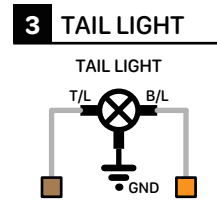
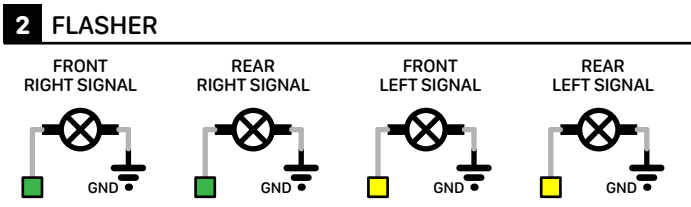
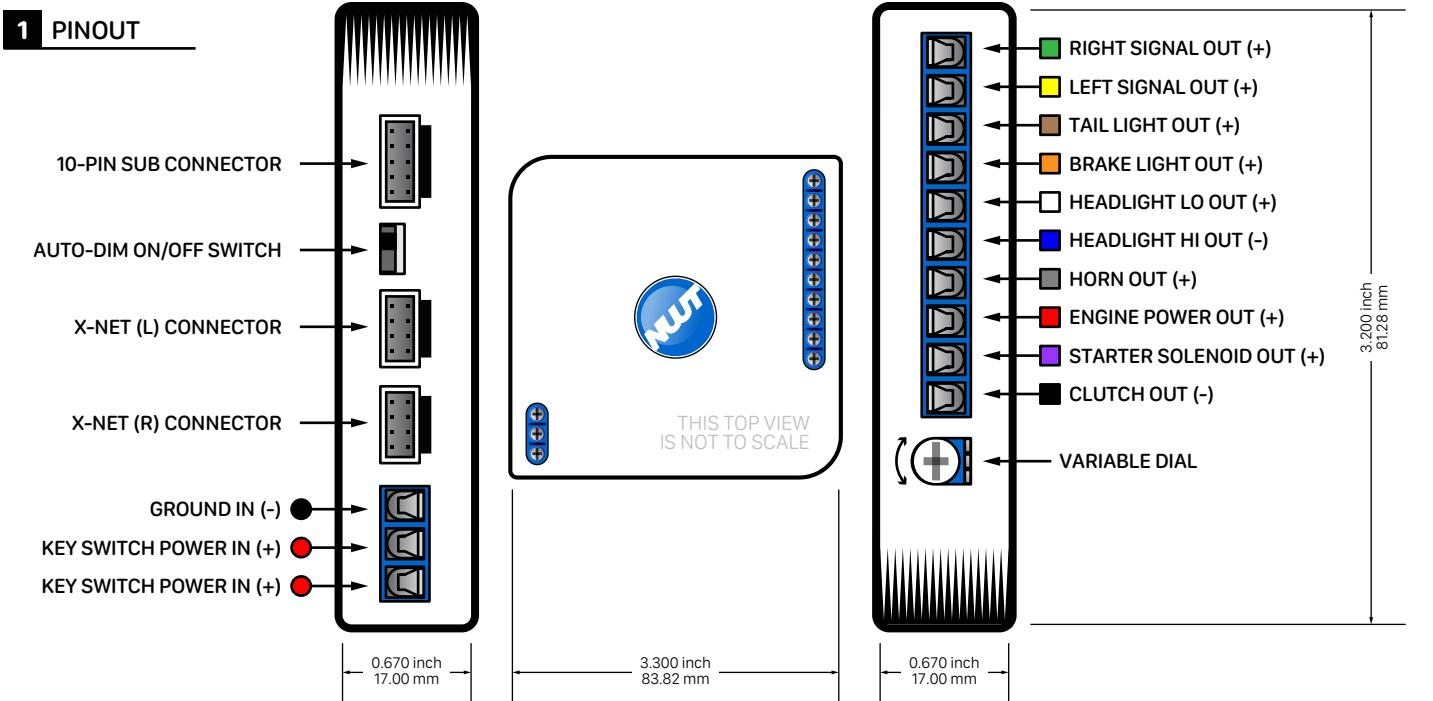

IMPORTANT

### WIRING CONNECTION & INSTALLATION BEST PRACTICES

**SHAPES AND COLOR IS A CONNECTION**

**KEEP MODULES AWAY FROM HEAT SOURCES**

BEST    GOOD    WORST

**MOUNT WITH LOGO FACING UP AND/OR OUT TO A SIDE**

**SOLDER WIRE TIPS BEFORE SECURING TO TERMINALS**

**TERMINALS SHOULD BE SNUG AND NOT OVER-TIGHTENED**

## 9 DASH INDICATORS (package includes resistors, SUB C. Part 2 of 2)

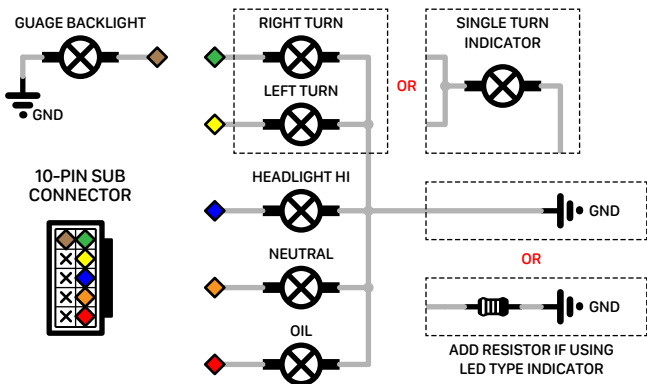

## 10 X-NET SWITCH INPUTS

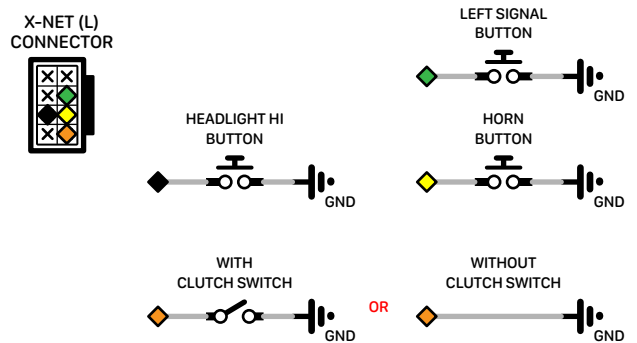

## 11 BUTTON FUNCTIONS

### ENGINE BUTTON

- 2 QUICK PUSH ●● - to toggle between Engine Power ON/OFF

### START BUTTON

- HOLD ——— - Hold to activate Starter

### HEADLIGHT BUTTON

- 1 QUICK PUSH ● - toggle between Headlight ON/OFF

### RIGHT SIGNAL BUTTON

- 1 LONG PUSH ——— - to activate TURN Signal (auto cancel after 6 minutes)  
 1 QUICK PUSH ● - to activate LANE CHANGE Signal (auto cancel after 5 seconds)  
 - to cancel active TURN and LANE CHANGE Signals  
 3 QUICK PUSH ●●● - to toggle HAZARD Lights ON/OFF (for **LEFT Hand Drive** countries)  
 4 QUICK PUSH ●●●● - FLASH PATTERN SELECTION (for **RIGHT Hand Drive** countries)

### LEFT SIGNAL BUTTON

- 1 LONG PUSH ——— - to activate TURN Signal (auto cancel after 6 minutes)  
 1 QUICK PUSH ● - to activate LANE CHANGE Signal (auto cancel after 5 seconds)  
 - to cancel active TURN and LANE CHANGE Signals  
 3 QUICK PUSH ●●● - to toggle HAZARD Lights ON/OFF (for **RIGHT Hand Drive** countries)  
 4 QUICK PUSH ●●●● - FLASH PATTERN SELECTION (for **LEFT Hand Drive** countries)

### HORN/HEADLIGHT BUTTON

- 1 QUICK PUSH ● - to active headlight FLASH TO PASS  
 2 QUICK PUSH ●● - toggle between Headlight HI/LO  
 HOLD ——— - sound Horn

## 12 FLASH PATTERN SELECTION

- Turn power ON
- Scroll through patterns by 4 QUICK PUSH of one of the following buttons:

For **Right Hand Drive** countries, use **RIGHT** Signal Button  
 For **Left Hand Drive** countries, use **LEFT** Signal Button

- PATTERN
- 1 - single burst (default)
  - 2 - double burst
  - 3 - single, then double burst
  - 4 - variable blink speed using VARIABLE DIAL
  - 5 - single sequential (sequential lights required)
  - 6 - half, then full sequential (sequential lights required)

- Leave it at desired pattern to set